

2024新品目录



Safe-Torque 快速



Zyklop 舒适棘轮



棘轮手柄



多么引人注目啊！

Zyklop 舒适棘轮 $\frac{3}{8}$ "

- 塑料套管带来的舒适感受
- 热塑镀膜表面防护
- 80细齿，小至 4.5° 的回转角
- 超薄型设计，手柄柔软，带人体工程学设计，方便在狭小空间作业
- 通过按钮安全锁住套筒，换向拨杆，方便换向



塑料涂层



塑料套管使得即使在低温下工作也很舒适和安全。



精密细齿

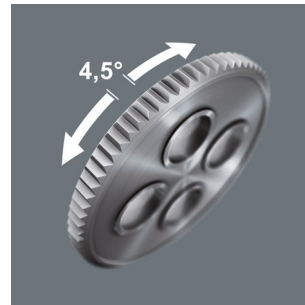

Zyklop 舒适型棘轮拥有 80 齿的细齿机构，允许仅 4.5° 的较小回转角。

适用于狭小空间



Zyklop 舒适型棘轮设计极其纤薄，即使在非常狭窄的空间也能轻松工作。



球锁

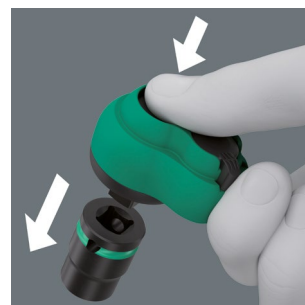

球锁能够使套筒和配件之间的连接更稳固，增加操作时的安全性。只需轻按按钮即可解除连接，更换工具。

8100 SB 12 Zyklop 舒适棘轮组套，转向杆， $\frac{3}{8}$ " 驱动，公制



16 件组套；置于表面柔顺、节省空间且坚固耐用的帆布工具袋内。尺寸小，重量轻，便携。

1 个 Zyklop 舒适棘轮，带 $\frac{3}{8}$ " 驱动转向杆，14 个 Zyklop Impaktor 套筒，1 个 Zyklop 加长件

05005530001		
○	8010 B	1x $\frac{3}{8}$ "x230,0
●	8790 B Impaktor	1x 8,0x30,0; 1x 10,0x30,0; 1x 11,0x30,0; 1x 12,0x30,0; 1x 13,0x30,0; 1x 14,0x30,0; 1x 15,0x30,0; 1x 16,0x30,0; 1x 17,0x30,0; 1x 18,0x30,0; 1x 19,0x30,0; 1x 21,0x32,0; 1x 22,0x32,0; 1x 24,0x32,0
○	8798 B	1x $\frac{3}{8}$ "x152,4

8100 SB 13 Zyklop 舒适棘轮组套，转向杆， $\frac{3}{8}$ " 驱动，英制



11 件组套；置于表面柔顺、节省空间且坚固耐用的帆布工具袋内。尺寸小，重量轻，便携。

1 个 Zyklop 舒适棘轮，带 $\frac{3}{8}$ " 驱动转向杆，9 个 Zyklop Impaktor 套筒，1 个 Zyklop 延长件

05005531001		
○	8010 B	1x $\frac{3}{8}$ "x230,0
●	8790 B Impaktor	1x $\frac{1}{4}$ "x30,0; 1x $\frac{5}{16}$ "x30,0; 1x $\frac{3}{8}$ "x30,0; 1x $\frac{7}{16}$ "x30,0; 1x $\frac{1}{2}$ "x30,0; 1x $\frac{9}{16}$ "x30,0; 1x $\frac{5}{8}$ "x30,0; 1x $\frac{11}{16}$ "x30,0; 1x $\frac{3}{4}$ "x30,0
○	8798 B	1x $\frac{3}{8}$ "x152,4

8010 B Zyklop 舒适棘轮，带转向杆， $\frac{3}{8}$ " 驱动



应用：带方头驱动的 $\frac{3}{8}$ " 方头套筒和 $\frac{3}{8}$ " 连接器；含球锁

设计：方便的塑料套管；超薄设计，即使在非常狭窄的空间也能工作；80 个齿的细齿，仅 4.5° 的回转角；转向杆可轻松改变方向；通过按钮锁定安全套筒

05005540001	
	$\frac{3}{8}$ " 230,0

9607 磁性条带 B Impaktor 1



10 件组套；磁性条带可暂时安装到墙壁、柜子、车间用滚轮小车。平滑旋转机构，用于安全储存并轻松查找工具。

10 件 Impaktor 方头套筒， $\frac{3}{8}$ " 驱动。带六角端头和套筒（含孔）。适合采用电动或气动扳手的应用， $\frac{3}{8}$ " 驱动。"Take it easy" 工具查找装置：根据尺寸进行颜色编码，可快速方便地找到所需工具。

05005451001		
●	8790 B Impaktor	1x 10,0x30,0; 1x 13,0x30,0; 1x 15,0x30,0; 1x 16,0x30,0; 1x 17,0x30,0; 1x 18,0x30,0; 1x 19,0x30,0; 1x 21,0x32,0; 1x 22,0x32,0; 1x 24,0x32,0
	9603	1x 30,0x340,0

有磁性

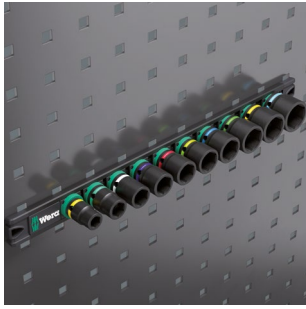

条带具有磁性, 适合暂时安装到墙壁、柜子、车间用滚轮小车。



TWIST TO UNLOCK

旋转解锁机构

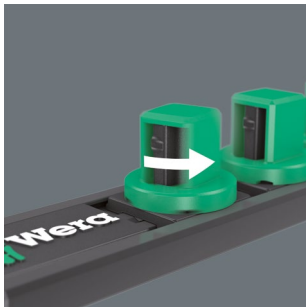

采用旋转扣构造, 套筒条带可用于轻松查找套筒。同时, 稳固固定套筒。

9608 磁性条带 B Impaktor Imperial 1

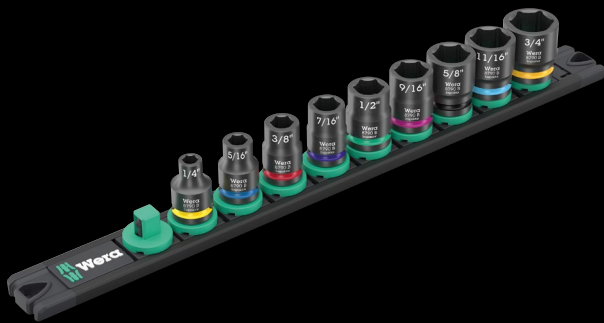

9件组套; 磁性条带可暂时安装到墙壁、柜子、车间用滚轮小车。平滑旋转机构, 用于安全储存并轻松查找工具。

9件 Impaktor 方头套筒, 3/8" 驱动。带六角端头和套筒(含孔)。适合采用电动或气动扳手的的应用, 3/8" 驱动。"Take it easy" 工具查找装置: 根据尺寸进行颜色编码, 可快速方便地找到所需工具。

05005452001		
●	8790 B Impaktor	1x 1/4"x30,0; 1x 5/16"x30,0; 1x 3/8"x30,0; 1x 7/16"x30,0; 1x 1/2"x30,0; 1x 9/16"x30,0; 1x 5/8"x30,0; 1x 11/16"x30,0; 1x 3/4"x30,0
	9601	1x 30,0x340,0

8790 B Impaktor 套筒扳手嵌件, 3/8" 驱动。



应用: 用于外六角螺栓和螺丝

设计: 即使在难以触及的联轴器和突出螺杆处也能使用; 3/8" 驱动; 带有锁销孔; 铬钼, 哑光黑色。"Take it easy" 工具查找装置: 按尺寸和尺寸印花方式进行颜色编码, 以便快速和容易地识别所需的批头套筒。

		●	○	⏏	⏏	⏏
		mm	mm	mm	mm	mm
05005500001		8.0		30.0	14.1	19.0
05005501001		10.0		30.0	16.6	19.0
05005502001		11.0		30.0	17.8	19.0
05005503001		12.0		30.0	18.2	19.0
05005504001		13.0		30.0	20.0	22.0
05005505001		14.0		30.0	21.0	22.0
05005506001		15.0		30.0	22.0	22.0
05005507001		16.0		30.0	22.0	24.0
05005508001		17.0		30.0	23.0	25.0
05005509001		18.0		30.0	23.0	26.0
05005510001		19.0		30.0	25.0	27.8
05005511001		21.0		32.0	27.0	30.0
05005512001		22.0		32.0	28.0	32.0
05005513001		24.0		32.0	30.0	34.0
05005514001			1/4"	30.0	11.0	19.0
05005515001			5/16"	30.0	14.1	19.0
05005516001			3/8"	30.0	16.6	19.0
05005517001			7/16"	30.0	17.8	19.0
05005518001			1/2"	30.0	20.0	22.0
05005519001			9/16"	30.0	21.0	22.0
05005520001			5/8"	30.0	22.0	24.0
05005521001			11/16"	30.0	23.0	25.0
05005522001			3/4"	30.0	25.0	28.0
05005523001			13/16"	32.0	27.0	30.0
05005524001			7/8"	32.0	28.0	32.0
05005525001			15/16"	32.0	30.0	34.0
05005526001			1"	32.0	32.0	36.0



适用于电动或气动冲击型工具



Impaktor技术可确保 Impaktor 套筒在极端条件下也能增加工具的平均使用寿命。

直观且非常紧凑的棘轮机构，也可用于旋转。



棘轮功能



带有细齿的集成棘轮 (36 齿) 和回转角 10° 可以在不需要重新定位工具的情况下放松和加速螺丝刀的驱动。

快速拆装螺丝



棘轮机构还允许在旋拧时快速“旋转”。

手柄棘轮机构



细齿集成棘轮保证快速安全工作。棘轮机构完全嵌入手柄中。由于手柄尺寸较小，棘轮甚至可以用于狭窄的旋拧场合。

换向开关



换向开关符合人体工程学。



Kraftform Kompakt 838 RA S Set 1



14 件组套

配有一把带棘轮功能的 838 RA S 批头夹持螺丝刀, 13 个批头, 化学镀镍, 带有 "Take it easy" 工具查找装置: 用特定颜色代表不同端头种类和尺寸, 有助于快速查找所需批头, 1/4", 长 50 mm

05051060001	
●	838 RA S 1x 1/4"x102
+	851/4 BTZ 1x PH 1x50; 1x PH 2x50
+	855/4 BTZ 1x PZ 1x50; 1x PZ 2x50
⊕	867/4 TORX® BTZ 1x TX 10x50; 1x TX 15x50; 1x TX 20x50; 1x TX 25x50
○	840/4 BTZ 1x 2,5x50; 1x 3,0x50; 1x 4,0x50; 1x 5,0x50
⊖	800/4 BTZ 1x 0,8x5,5x50
	魔术贴 70 1x 50,0x70,0

Kraftform Kompakt 838 RA S Imperial Set 1



14 件组套

配有一把带棘轮功能的 838 RA S 批头夹持螺丝刀, 13 个批头, 化学镀镍, 带有 "Take it easy" 工具查找装置: 用特定颜色代表不同端头种类和尺寸, 有助于快速查找所需批头, 1/4", 长 50 mm

05051065001	
●	838 RA S 1x 1/4"x102
+	851/4 BTZ 1x PH 1x50; 1x PH 2x50
⊕	867/4 TORX® BTZ 1x TX 10x50; 1x TX 15x50; 1x TX 20x50; 1x TX 25x50
○	840/4 Z 1x 9/64"x50; 1x 5/32"x50; 1x 3/16"x50; 1x 7/32"x50
⊖	800/4 BTZ 1x 0,8x5,5x50
○	868/4 1x # 1x50; 1x # 2x50
	魔术贴 70 1x 50,0x70,0

具有棘轮功能的 838 RA S 批头夹持螺丝刀, 1/4"



应用: 适用于带 1/4" 外六角驱动批头

设计: 手柄 (36 齿, 回转角 10°) 集成细齿棘轮; 采用 1/4" 外六角驱动批头, 安装 1/4" 六角套筒, 磁性

手柄: Kraftform 配六角防滚动保护, 多重材料

05051492001	
●	1/4" 102 84



“易寻”色标系统

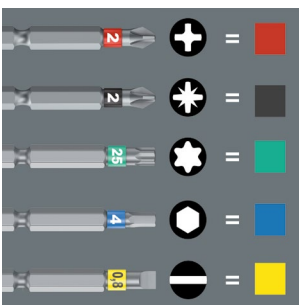

“易寻”色标系统用特定的颜色代表不同花形, 再辅以简洁的尺寸标示, 让寻找工具变得简单快速。

Kraftform Kompakt 838 RA-R M Set 1



15 件组套

配有一把带棘轮功能的 838 RA-R M 批头夹持螺丝刀, 14 个批头, 化学镀镍, 1/4", 长 89 mm

05051061001	
●	838 RA-R M 1x 1/4"x123,5
+	851/4 Z 1x PH 1x89; 1x PH 2x89; 1x PH 3x89 ¹⁾
+	855/4 Z 1x PZ 1x89; 1x PZ 2x89; 1x PZ 3x89 ¹⁾
⊗	867/4 Z 1x TX 10x89; 1x TX 15x89; 1x TX 20x89; TORX® 1x TX 25x89
○	840/4 Z 1x 3,0x89; 1x 4,0x89; 1x 5,0x89
⊖	800/4 Z 1x 1,0x5,5x89
	魔术贴 70 1x 50,0x70,0

¹⁾ 六角形刀片

Kraftform Kompakt 838 RA-R M Imperial Set 1



15 件组套

配有一把带棘轮功能的 838 RA-R M 批头夹持螺丝刀, 14 个批头, 化学镀镍, 1/4", 长 89 mm

05051066001	
●	838 RA-R M 1x 1/4"x123,5
+	851/4 Z 1x PH 1x89; 1x PH 2x89; 1x PH 3x89 ¹⁾
⊗	867/4 Z 1x TX 10x89; 1x TX 15x89; 1x TX 20x89; TORX® 1x TX 25x89
○	840/4 Z 1x 1/8"x89; 1x 5/32"x89; 1x 3/16"x89
⊖	800/4 Z 1x 1,0x5,5x89
○	868/4 1x # 1x89; 1x # 2x89; 1x # 3x89
	魔术贴 70 1x 50,0x70,0

¹⁾ 六角形刀片

具有棘轮功能的838 RA-R M 批头夹持螺丝刀, 1/4"



应用: 适用于符合 DIN ISO 1173-C 6.3 和 E 6.3 要求的带 1/4" 外六角驱动头的批头, 以及 Wera 连接系列 1、4

设计: 手柄 (36 齿, 回转角 10°) 集成细齿棘轮; 1/4" 六角, 带 Rapidaptor 快速接头, 可以单手操作换装批头, 有磁性

手柄: Kraftform 配六角防滚动保护, 多重材料

05051493001	
●	mm
○	mm
	1/4" 123,5 98



全系夹持

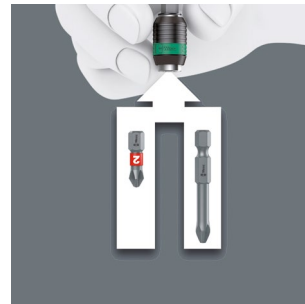

可用于 DIN ISO 1173-C 6.3 和 E 6.3 标准的 1/4" 驱动批头, 以及维拉系列 1 和 4 的批头。



快装和自锁

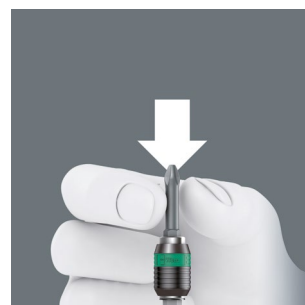

无需移动护套即可将批头推入接头。一旦批头夹在接头上, 即可自动锁住。

Kraftform Kompakt VDE 17 RA 1*



17 件组套

一把带棘轮功能的 837 i RA 批头夹持螺丝刀 (40 齿, 回转角 9°), 一个仅用于 Wera VDE 刀杆的 817 VDE 批头夹持螺丝刀。15 个 VDE 刀杆 (每个 157 mm 长), 带有 "Take it easy" 工具查找装置: 带有侧面彩色编码和激光雕刻尺寸指示

Kraftform Kompakt VDE 17 RA Imperial 1*



17 件组套

一把带棘轮功能的 837 i RA 批头夹持螺丝刀 (40 齿, 回转角 9°), 一个仅用于 Wera VDE 刀杆的 817 VDE 批头夹持螺丝刀。15 个 VDE 刀杆 (每个 157 mm 长), 带有 "Take it easy" 工具查找装置: 带有侧面彩色编码和激光雕刻尺寸指示

05006618001		
●	837 i RA	1x 9x115
●	817 VDE	1x 9x98
+	Kraftform Kompakt VDE 62 i Take it easy	1x PH 1x157; 1x PH 2x157
+	Kraftform Kompakt VDE 65 i Take it easy	1x PZ 1x157; 1x PZ 2x157
+	Kraftform Kompakt VDE 65 i PZ/S Take it easy	1x # 1x157; 1x # 2x157
+	Kraftform Kompakt VDE 67 i Take it easy	1x TX 10x157; 1x TX 15x157; 1x TX 20x157; 1x TX 25x157
●	Kraftform Kompakt VDE 60 i Take it easy	1x 0,4x2,5x157; 1x 0,8x4,0x157; 1x 1,0x5,5x157; 1x 1,2x6,5x157
●	Kraftform Kompakt VDE 60 iS Take it easy	1x 0,6x3,5x157

* 2024年6月上市

05006619001		
●	837 i RA	1x 9x115
●	817 VDE	1x 9x98
+	Kraftform Kompakt VDE 62 i Take it easy	1x PH 1x157; 1x PH 2x157
+	Kraftform Kompakt VDE 65 i PZ/S Take it easy	1x # 1x157; 1x # 2x157
+	Kraftform Kompakt VDE 67 i Take it easy	1x TX 10x157; 1x TX 15x157; 1x TX 20x157; 1x TX 25x157
●	Kraftform Kompakt VDE 60 i Take it easy	1x 0,4x2,5x157; 1x 0,8x4,0x157; 1x 1,0x5,5x157; 1x 1,2x6,5x157
●	Kraftform Kompakt VDE 60 iS Take it easy	1x 0,6x3,5x157
○	Kraftform Kompakt VDE 68 i Take it easy	1x # 1x157; 1x # 2x157

* 2024年6月上市

具有棘轮功能的 837 i RA Kraftform 批头夹持螺丝刀*



应用： 仅用于 Wera VDE 刀杆

设计： 手柄 (40 齿, 回转角 9°) 集成细齿棘轮

手柄： Kraftform 配六角防滚动保护, 多重材料

	mm	mm
05057490001	9	115

* 2024年6月上市



螺丝刀带“Take it easy”易寻色标系统

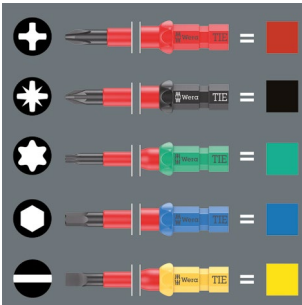

Kraftform Kompakt VDE 刀杆配有“Take it easy”工具查找装置。通过轮廓的颜色编码和激光雕刻的尺寸指示, 可以很容易地快速识别所需的工具。

快速旋转

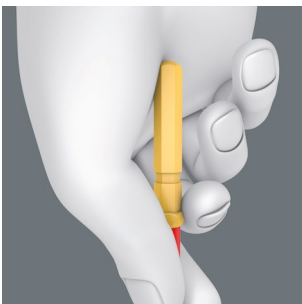

手掌舒适地支撑在刀杆后端的圆形上。这允许快速旋转刀杆并加速旋转过程。

具有棘轮功能的 837 i RA 螺丝刀

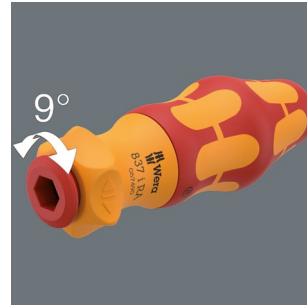

带有细齿的集成棘轮 (40 齿和回转角 9°) 可以在不需要重新定位工具的情况下放松和加速螺丝刀的驱动。

快速拆装螺丝

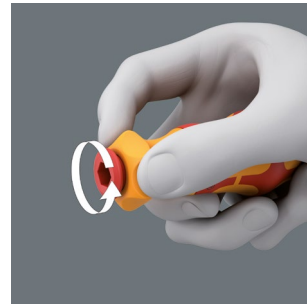

棘轮机构还允许在旋拧时快速“旋转”。

817 VDE 批头夹持螺丝刀

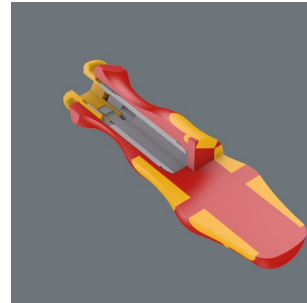

批头夹持螺丝刀仅适用于 Wera VDE 刀杆。Kraftform Plus 手柄, 符合人体工学设计的舒适旋拧操作舒适, 可避免出现起泡和老茧。硬质手柄区域, 适合较高的操作速度, 软质手柄区域则适用于高扭矩传输。



绝缘强度测试



按照 IEC 60900 的标准, 每件 Kraftform Kompakt VDE 绝缘组套都通过了 10,000 伏的水浴测试。这一 10 倍负荷的测试确保其在 1,000 伏的环境下能安全工作。

新: Kraftform Kompakt VDE 刀杆,
带 "Take it easy" 工具查找装置。



Kraftform Kompakt VDE Big Pack 1



26 件组套

2 个仅用于 Wera VDE 刀杆的 817 VDE 批头夹持螺丝刀, 24 个 VDE 刀杆 (每个 157 mm 长), 带有 "Take it easy" 工具查找装置, 带有侧面彩色编码和激光雕刻尺寸指示

织物耐用卷袋

Kraftform Kompakt VDE 17 通用型 1 工具查找装置



17 件组套

2 个仅用于 Wera VDE 刀杆的 Kraftform 817 VDE 批头夹持螺丝刀

15 个 VDE 刀杆 (每个 157 mm 长), 带有 "Take it easy" 工具查找装置: 带有侧面彩色编码和激光雕刻尺寸指示

装在坚固的腰带皮套中

05006617001		
●	817 VDE	2x 9x98
+	Kraftform Kompakt VDE 62 iS Take it easy	1x PH 1x157; 1x PH 2x157
+	Kraftform Kompakt VDE 65 iS Take it easy	1x PZ 1x157; 1x PZ 2x157
+	Kraftform Kompakt VDE 62 iS PH/S Take it easy	1x # 1x157; 1x # 2x157
+	Kraftform Kompakt VDE 65 iS PZ/S Take it easy	1x # 1x157; 1x # 2x157
+	Kraftform Kompakt VDE 67 i Take it easy	1x TX 8x157; 1x TX 9x157; 1x TX 10x157; 1x TX 30x157
+	Kraftform Kompakt VDE 67 iS Take it easy	1x TX 15x157; 1x TX 20x157; 1x TX 25x157
○	Kraftform Kompakt VDE 64 i Take it easy	1x 2,5x157; 1x 3,0x157; 1x 4,0x157; 1x 5,0x157
●	Kraftform Kompakt VDE 60 i Take it easy	1x 0,4x2,5x157; 1x 1,2x6,5x157
●	Kraftform Kompakt VDE 60 iS Take it easy	1x 0,6x3,5x157; 1x 0,8x4,0x157; 1x 1,0x5,5x157

05006611001		
●	817 VDE	2x 9x98
+	Kraftform Kompakt VDE 62 i Take it easy	1x PH 1x157; 1x PH 2x157
+	Kraftform Kompakt VDE 65 i Take it easy	1x PZ 1x157; 1x PZ 2x157
+	Kraftform Kompakt VDE 65 i PZ/S Take it easy	1x # 1x157; 1x # 2x157
+	Kraftform Kompakt VDE 67 i Take it easy	1x TX 10x157; 1x TX 15x157; 1x TX 20x157; 1x TX 25x157
●	Kraftform Kompakt VDE 60 i Take it easy	1x 0,4x2,5x157; 1x 0,8x4,0x157; 1x 1,0x5,5x157; 1x 1,2x6,5x157
●	Kraftform Kompakt VDE 60 iS Take it easy	1x 0,6x3,5x157
	魔术贴 70	1x 50,0x70,0



不仅安全,而且快捷。

Safe-Torque 快速

- 可快速调整扭矩的扭力起子
- 轻松快速的扭矩设置
- 固定位置 (扭矩锁) 用于无限制的拧紧和松开扭矩
- 顺时针/逆时针扭矩控制的安全滑动扭矩功能
- 达到设定扭矩后, 不能对工具进行过度拧紧, 以免施加过度扭矩 (精度 $\pm 10\%$)



五种可选的拧紧扭矩



五个可选的拧紧扭矩和一个固定位置 (扭矩锁) 的无限拧紧和松开扭矩。

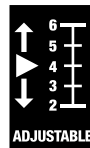

设置简单



易于设置可选的拧紧扭矩。



超负荷信号

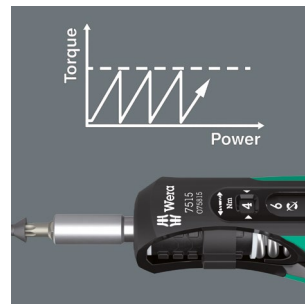

达到设定扭矩数值时可听到清晰的超负荷信号。



7515/16 Kraftform Safe-Torque 快速通用型 1



16 件组套

带一个 7515 扭矩扳手的折叠袋,可轻松快速设置扭矩和 15 个硬批头 (长 89 mm)

05075851001	7515	1x 1/4"x2,0x3,0x4,0x5,0x6,0x147,5
+	851/4 Z	1x PH 2x89
⊕	867/4 Z TORX® BO	1x TX 10x89; 1x TX 15x89; 1x TX 20x89; 1x TX 25x89; 1x TX 30x89
⊕	867/4 IP TORX PLUS®	1x 10 IPx89; 1x 15 IPx89; 1x 20 IPx89; 1x 25 IPx89; 1x 30 IPx89
○	840/4 Z	1x 3,0x89; 1x 4,0x89; 1x 5,0x89; 1x 6,0x89 ¹⁾

¹⁾ 六角形刀片



7515/7 Kraftform Safe-Torque 快速自行车型 1



7 件组套

带一个 7515 扭矩扳手的折叠袋,可轻松快速设置扭矩和 6 个硬批头 (长 50 mm),带 Wera "Take it easy" 工具查找装置:根据输出进行尺寸压印标记和颜色编码,可助您轻松找到所需的批头

05075850001	7515	1x 1/4"x2,0x3,0x4,0x5,0x6,0x147,5
⊕	867/4 TORX® BTZ	1x TX 10x50; 1x TX 25x50
○	840/4 BTZ	1x 2,5x50; 1x 3,0x50; 1x 4,0x50; 1x 5,0x50

7515 Kraftform Safe-Torque 快速扭矩扳手, 2-6 Nm



应用: 适用于带 1/4" 外六角驱动批头

设计: 五个可选的最大拧紧扭矩和一个固定位置;批头支座精度为 ±10%。扭矩值的数字显示。达到设定扭矩时发出可靠信号。

手柄: Kraftform 配六角防滚动保护,多重材料

05075815001	1/4"	2.0	3.0	4.0	5.0	6.0	147.5
-------------	------	-----	-----	-----	-----	-----	-------



用于螺栓连接硬质合金嵌件



工具组套特别适用于螺栓连接硬质合金嵌件。Safe-Torque Speed 7510 扭矩扳手具有领先的硬质合金工具制造商推荐的五个可选扭矩值，确保可更换硬质合金刀杆的可靠扭矩控制螺纹连接。

用于硬质合金嵌件的 7510/14 Safe-Torque 快速工具组套



7510 Kraftform Safe-Torque 快速扭矩扳手，1-3 Nm

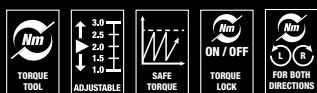

应用： 适用于带 1/4" 外六角驱动批头

设计： 五个可选的最大拧紧扭矩和一个固定位置；批头支座精度为 ±10 %。扭矩值的数字显示。达到设定扭矩时发出可靠信号。

手柄： Kraftform 配六角防滚动保护，多重材料

	Nm	Nm	Nm	Nm	Nm	mm
05075810001	1.0	1.5	2.0	2.5	3.0	147.5



14 件组套

带一个 Safe-Torque 快速 7510 扭矩扳手的折叠袋，可轻松快速设置扭矩，13 个用于 TORX®、TORX PLUS® 和内六角螺丝的硬批头（长 25 mm）

特别适合轻松更换硬质合金嵌件。

05075840001		
7510	1x 1/4"x1,0x1,5x2,0x2,5x3,0x147,5	
867/1 IP TORX PLUS®	1x 7 IPx25; 1x 8 IPx25; 1x 9 IPx25; 1x 10 IPx25; 1x 15 IPx25	
867/1 TORX®	1x TX 7x25; 1x TX 8x25; 1x TX 9x25; 1x TX 10x25; 1x TX 15x25	
840/1 Z	1x 2,0x25; 1x 2,5x25; 1x 3,0x25	

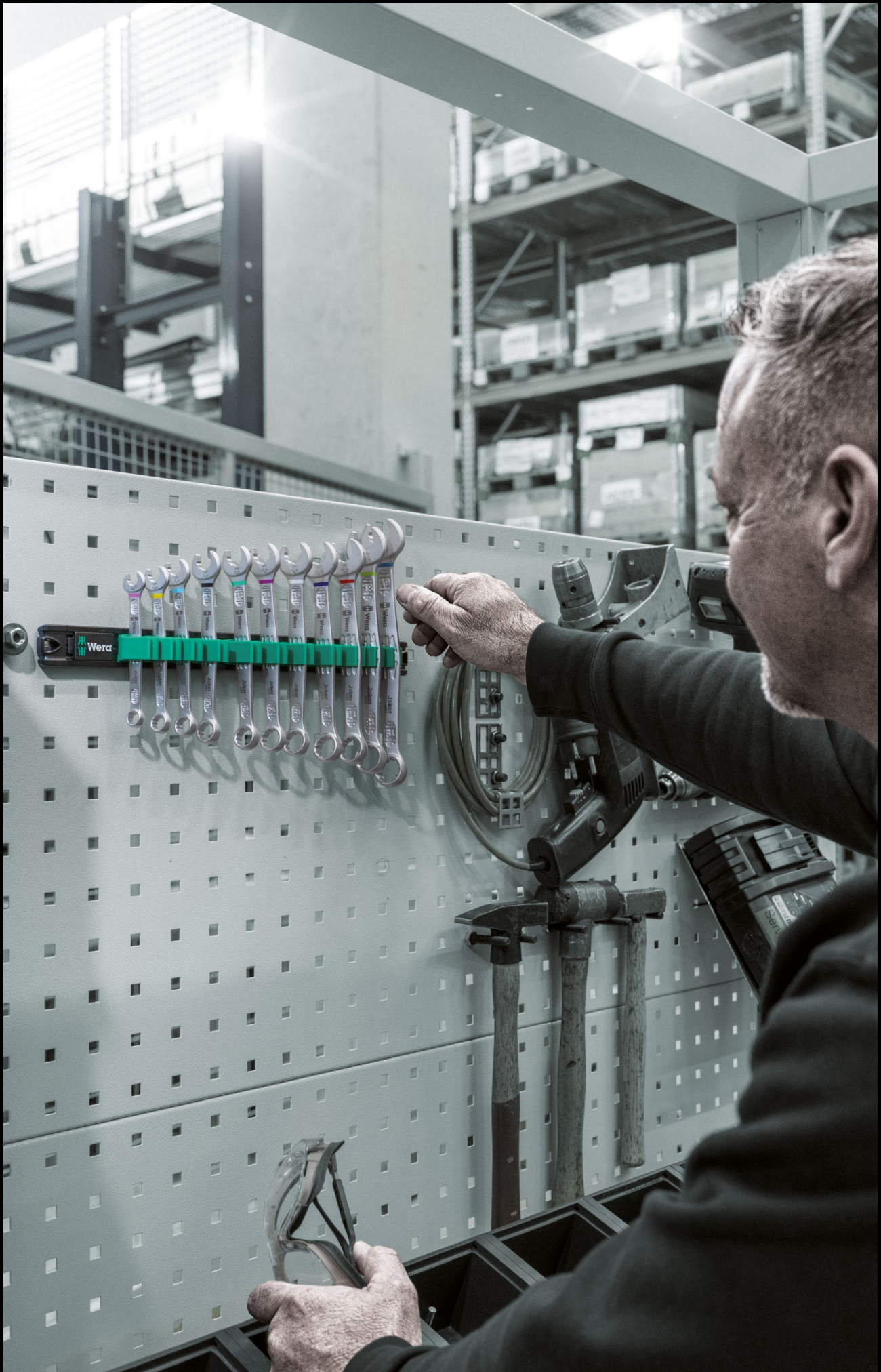

9630 磁性条带 6000 Joker 1 环形棘轮扳手组套



环形棘轮扳手组套，公制尺寸
11 件组套
在接线盒上

05020014001	6000 Joker	1x 8x144; 1x 10x159; 1x 11x165; 1x 12x170,7; 1x 13x177; 1x 14x188; 1x 15x200; 1x 16x212; 1x 17x224; 1x 18x235; 1x 19x246
	9610	1x 30,0x370,0

9631 磁性条带 6000 Joker 2 环形棘轮扳手组套



环形棘轮扳手组套，公制尺寸
5 件组套
在接线盒上

05020015001	6000 Joker	1x 8x144; 1x 10x159; 1x 13x177; 1x 17x224; 1x 19x246
	9610	1x 30,0x370,0

牢固的工具夹持

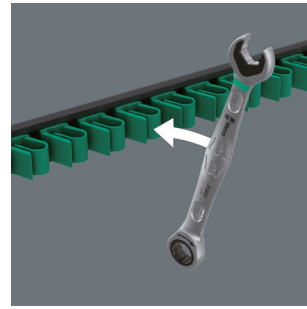

高品质的铝制接线盒最多可容纳 11 把扳手。夹紧弹簧牢牢地夹住工具。



由磁力保持

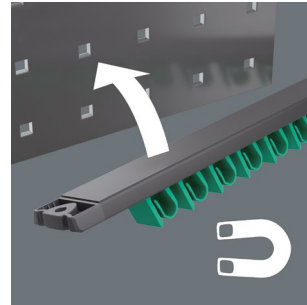

凭借其强大的磁性，条形端头可以牢固地附着在金属表面。

螺丝安装



条带也可以用螺栓固定在墙上。



棘轮梅花扳手 Joker 6000，双边环



Joker系列的固定功能意味着螺栓和螺帽能被扳手头固定并轻松定位。因为采用了创新的特殊挡块来固定紧固件，它可快速、安全地进行紧固，从而避免浪费时间去寻找掉落的螺栓和螺帽！螺栓或螺帽定位好后，就可以快速地进行紧固，而无需使用任何额外的工具。

9632 磁性条带 6000 Joker Imperial 1 环形棘轮扳手组套

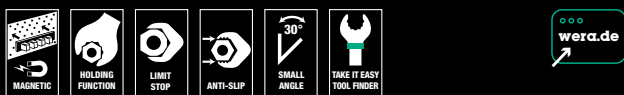

环形棘轮扳手组套, 英制尺寸
8 件组套
在接线盒上

05020016001	
6000 Joker Imperial	1x 5/16"x144; 1x 3/8"x159; 1x 7/16"x165; 1x 1/2"x177; 1x 9/16"x188; 1x 5/8"x212; 1x 11/16"x235; 1x 3/4"x246
9610	1x 30,0x370,0

9641 磁性条带 6003 Joker 2 梅花扳手组套

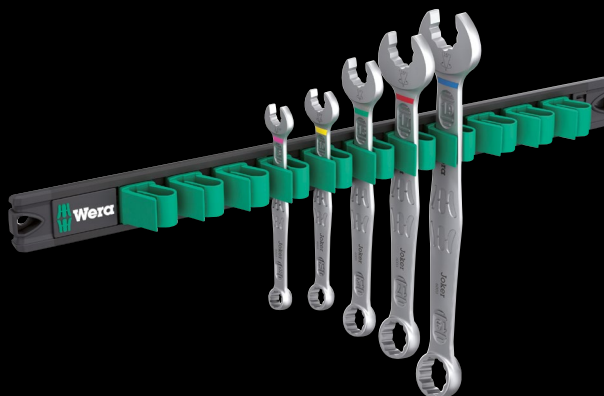
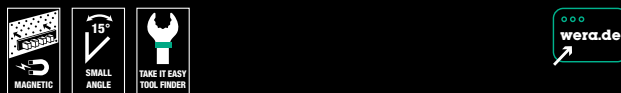

环形扳手组套, 公制尺寸, 扳手开口的回转角为 7.5°
5 件组套
在接线盒上

05020234001	
6003 Joker	1x 8x115; 1x 10x125; 1x 13x160; 1x 17x190; 1x 19x230,0
9610	1x 30,0x370,0

9640 磁性条带 6003 Joker 1 环形扳手组套

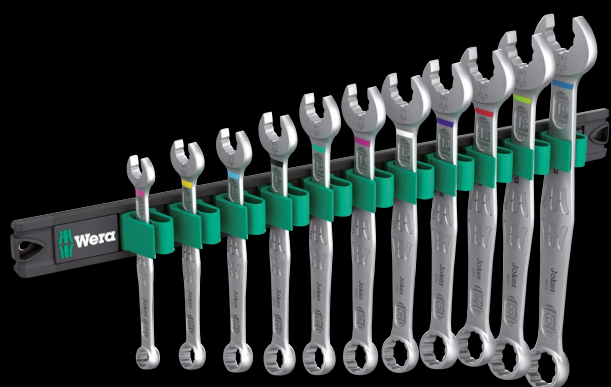
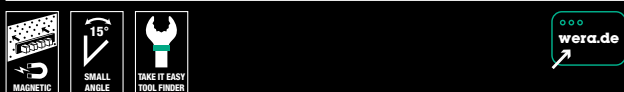

环形扳手组套, 公制尺寸, 扳手开口的回转角为 7.5°
11 件组套
在接线盒上

05020233001	
6003 Joker	1x 8x115; 1x 10x125; 1x 11x135; 1x 12x148; 1x 13x160; 1x 14x167; 1x 15x174; 1x 16x182; 1x 17x190; 1x 18x210; 1x 19x230,0
9610	1x 30,0x370,0

9642 磁性条带 6003 Joker Imperial 1 环形扳手组套

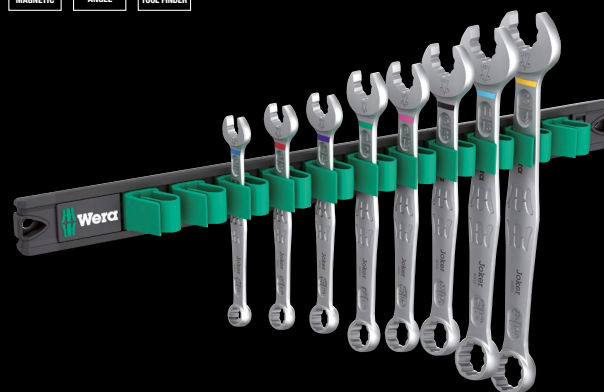

环形扳手组套, 英制尺寸, 扳手开口的回转角为 7.5°
8 件组套
在接线盒上

05020235001	
6003 Joker Imperial	1x 5/16"x115; 1x 3/8"x125; 1x 7/16"x135; 1x 1/2"x160; 1x 9/16"x167; 1x 5/8"x182; 1x 11/16"x210; 1x 3/4"x230,0
9610	1x 30,0x370,0

9610 Joker 磁性条带，最多可用于 11 个扳手，空袋

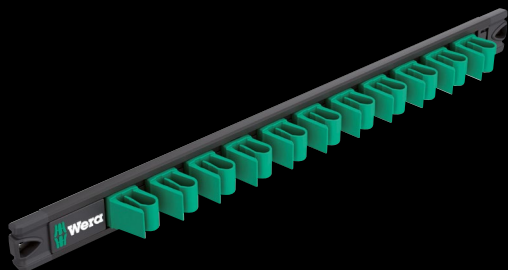

一条磁性条带，空袋。最多 11 个 Joke 扳手。条带允许临时连接到金属表面，也可以用螺栓固定到墙上。由于采用了坚固的端头，条带确保了可靠的夹紧和方便的工具操作。

	mm	mm
05136413001	30.0	370.0

牢固的工具夹持

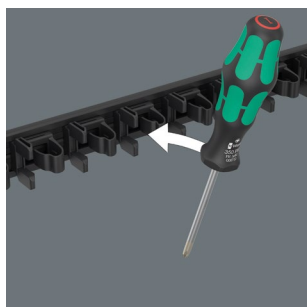

塑料的接线盒最多可容纳 9 把 Kraftform 螺丝刀。夹紧弹簧牢牢地夹住工具。

由磁力保持

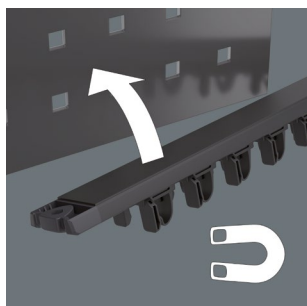

凭借其强大的磁性，条形端头可以牢固地附着在金属表面。

螺丝安装



条带也可以用螺栓固定在墙上。

9650 磁性条带 Kraftform 螺丝刀组套



9 件组套

6 把 Kraftform 系列 300 螺丝刀；适用于十字螺丝 Phillips 和 Pozidriv (带 Lasertip) 和 TORX® 螺丝。一把 Kraftform 系列 100 VDE 一字螺丝刀，缩小刀杆直径。带 "Take it easy" 工具查找装置：用特定颜色代表不同端头种类和尺寸。2 把用于一字螺丝的凿子；用于旋拧、凿切和棒接。一个接线盒，可以通过磁铁牢固地连接到金属表面。条带也可以用螺栓固定在墙上。

	mm	mm
05051012001		
⊖	932 A	1x 1,0x5,5x100; 1x 1,2x7,0x125
⊕	350	1x PH 2x100
⊕	355	1x PZ 1x80; 1x PZ 2x100
⊗	367 TORX®	1x TX 20x100; 1x TX 25x100
⊖	335	1x 0,8x4,0x100
⊖	160 iS VDE	1x 0,6x3,5x100
	9611	1x 30,0x400,0

9611 磁性条带，最多可用于 9 个 Kraftform 螺丝刀，空袋

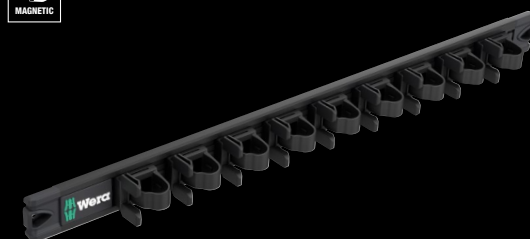

一条磁性条带，空袋。最多可用于 9 个 Kraftform 螺丝刀。条带允许临时连接到金属表面，并且由于具有坚固的端子，确保了可靠的夹紧和工具的方便使用。条带也可以用螺栓固定在墙上。

	mm	mm
05136414001	30.0	400.0



9620 皮带套组套 1



9 件组套

5 个 Kraftform 系列 300 螺丝刀; 适用于十字头螺丝的十字螺丝和 PZ 米字 (带激光蚀刻刀头) 和 TORX® 螺丝。3 个 Kraftform 系列 100 VDE 螺丝刀; 适用于十字头螺丝的十字螺丝 (带激光蚀刻刀头) 和一字螺丝。"易寻"工具查找装置: 用特定颜色代表不同端头种类和尺寸。1 个用于一字螺丝的凿子扳手, 用于埋头螺丝的旋拧、凿切和榫接。1 个耐用和坚固的皮套 - 可以连接到皮带上。

05136032001		
+	350	1x PH 1x80; 1x PH 2x100
+	355	1x PZ 2x100
⊕	367 TORX®	1x TX 20x100; 1x TX 25x100
⊖	932 A	1x 1,2x7,0x125
+	162 i VDE PH	1x PH 1x80; 1x PH 2x100
⊖	160 i VDE	1x 0,6x3,5x100 ¹⁾
	9522	1x 170,0x240,0

¹⁾ 不带Lasertip激光蚀刻刀头

9622 皮带套组套 3



7 件组套

3 个 Kraftform 系列 100 VDE 螺丝刀; 适用于内四角套筒螺丝和一字螺丝的螺丝刀。3 个 Kraftform 系列 1800 螺丝刀; 适用于十字头螺丝的十字螺丝和一字螺丝 (带激光蚀刻刀头和球型手柄)。"易寻"工具查找装置: 用特定颜色代表不同端头种类和尺寸。1 个用于一字螺丝的凿子扳手, 用于埋头螺丝的旋拧、凿切和榫接。1 个耐用和坚固的皮套 - 可以连接到皮带上。

05300306001		
+	1850 PH	1x PH 1x80; 1x PH 2x100
⊖	1834	1x 1,0x6,0x100
⊖	932 A	1x 1,0x5,5x100
⊖	160 i VDE	1x 0,6x3,5x100 ¹⁾
○	168 i VDE	1x # 1x80; 1x # 2x100
	9522	1x 170,0x240,0

¹⁾ 不带Lasertip激光蚀刻刀头

9621 皮带套组套 2



7 件组套

3 个 Kraftform 系列 100 VDE 螺丝刀; 适用于十字头的十字螺丝 (带激光蚀刻刀头) 和一字螺丝。3 个 Kraftform 系列 1800 螺丝刀; 适用于十字头螺丝的十字螺丝和一字螺丝 (带激光蚀刻刀头和球型手柄)。"易寻"工具查找装置: 用特定颜色代表不同端头种类和尺寸。1 个用于一字螺丝的凿子扳手, 用于埋头螺丝的旋拧、凿切和榫接。1 个耐用和坚固的皮套 - 可以连接到皮带上。

05136033001		
+	1850 PH	1x PH 1x80; 1x PH 2x100
⊖	1834	1x 1,0x6,0x100
⊖	932 A	1x 1,0x5,5x100
+	162 i VDE PH	1x PH 1x80; 1x PH 2x100
⊖	160 i VDE	1x 0,6x3,5x100 ¹⁾
	9522	1x 170,0x240,0

¹⁾ 不带Lasertip激光蚀刻刀头

可以夹在皮带上



皮带工具袋用耐用材料制成, 可以连接到皮带上。



适合高扭矩的 Kraftform 球型手柄

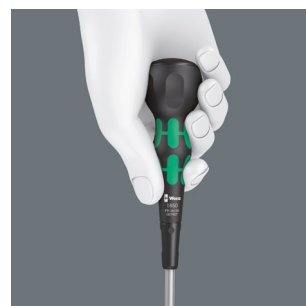

符合人体工程学设计的 Kraftform 球型手柄正好适合手握。它的凸形实现了高扭矩传输。

真正的一体化机架。

950/9 Hex-Plus 多色 3 L 型扳手组套，公制，BlackLaser

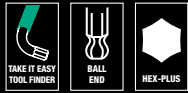

9 件组套，放在架子上，借助 9109 墙壁支架/底座，可以直立放在桌子上，也可以挂在墙上；用于移动使用的集成式可拆卸夹 9539，用于工具头磁化和退磁的集成式可拆卸磁铁 9538

应用： 内六角螺丝

设计： BlackLaser 表面，带软管护套。L 型扳手具有颜色编码和尺寸标记，可以很容易找到。

球头： 长臂带 Hex-Plus 六角球头

05133165001		
○	950 SPKL Multicolour	1x 1,5x90; 1x 2,0x101; 1x 2,5x112; 1x 3,0x123; 1x 4,0x137; 1x 5,0x154; 1x 6,0x172; 1x 8,0x195; 1x 10,0x224
	9539	
	9109	
	9538	

950/9 Hex-Plus 8 L 型扳手组套，公制，镀铬



9 件组套，放在架子上，借助 9109 墙壁支架/底座，可以直立放在桌子上，也可以挂在墙上；用于移动使用的集成式可拆卸夹 9536，用于工具头磁化和退磁的集成式可拆卸磁铁 9538

应用： 内六角螺丝

设计： 镀铬

球型批头： 长臂带 Hex-Plus 六角增强型球头

05022102001		
○	950 PKL	1x 1,5x90 ¹⁾ ; 1x 2,0x100; 1x 2,5x112; 1x 3,0x126; 1x 4,0x140; 1x 5,0x160; 1x 6,0x180; 1x 8,0x200; 1x 10,0x219
	9109	
	9536	
	9538	

¹⁾ 正六边形



Hex-Plus



内六角螺丝存在一个问题，由于从扳手头传递外力到螺丝的接触面很窄，导致螺丝头可能会损坏，通常是凹处被磨圆。Hex-Plus花形有较大的接触面，可防止这种损坏。它从凹槽的平面处驱动螺丝，而不是从角面，因此和一般L型扳手相比增加了20%可以被传递的扭矩。并且Hex-Plus工具适合每一个标准内六角螺丝。

了20%可以被传递的扭矩。并且Hex-Plus工具适合每一个标准内六角螺丝。

巧妙存放 L 型扳手



L型扳手支架可安放在桌面上或者悬挂在墙壁上。

便携工具夹



工具夹可拆卸；因此可方便取放 L 型扳手。

可拆卸式加消磁器

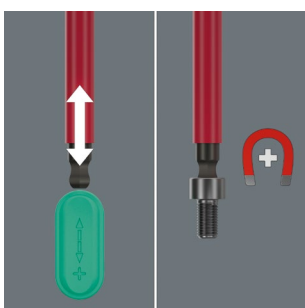

该支架内置智能化可拆卸加消磁器，该装置可用于磁化（和消磁）螺丝和工具批头。



950/9 Hex-Plus 多色 3 L 型扳手组套，英制，BlackLaser



9 件组套，双组分工具夹

应用：内六角螺丝

设计：BlackLaser 表面，带软管护套。所有 L 型扳手均带有彩色编码和尺寸标记，方便取用。

球型批头：长臂带 Hex-Plus 六角增强型球头

05022641001		
○	950 SPKS Multicolour	1x 5/64"x50; 1x 3/32"x56; 1x 1/8"x63; 1x 5/32"x71; 1x 3/16"x80; 1x 7/32"x90; 1x 1/4"x100; 1x 5/16"x112; 1x 3/8"x125



车间用 9532 链条铆接机组套



最薄弱的链节。

20 件组套

一个 Wera Zyklop Mini 1 批头棘轮，落锻实心钢设计；根据 DIN ISO 1173-C 6.3 和 E 6.3 及 Wera 连接系列 1 和 4，适用于安装带 1/4" 外六角驱动的批头，一个 816 R 批头夹持螺丝刀，一个链条铆接机，一个链条紧固件，配件组套链条铆接机销，一个链条锁工具，10 个 89 mm 长的批头，2 个 25 mm 长的批头，一个坚固的折叠袋

05136042001		
●	8001 A	1x 1/4"x87,0
●	816 R	1x 1/4"x119
+	851/4 Z	1x PH 1x89; 1x PH 2x89
⊖	867/4 Z	1x TX 10x89; 1x TX 25x89
	TORX®	
○	840/4 Z	1x 2,0x89; 1x 2,5x89; 1x 3,0x89; 1x 4,0x89; 1x 5,0x89; 1x 6,0x89 ¹⁾
○	840/1 Z	1x 5,0x25; 1x 8,0x25
	9512 Chain-Hook	
	9513 Chain 工具	
	9533 快速释放自行车链条工具	1x 167,5
	9534	3x 15,0

¹⁾ 六角形刀片

链条工具

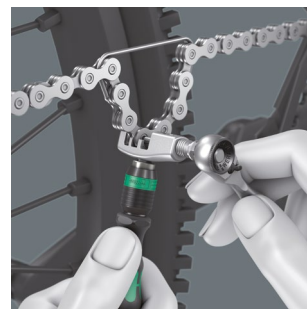

使用附带的链条工具，可以松开和重新连接链条；用于打开和关闭自行车链条。适用于单速链条，最高可达 12 速。

链条锁工具

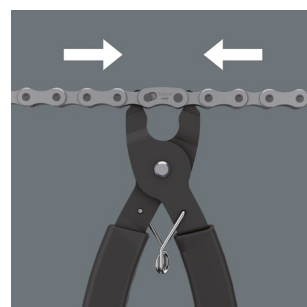

链条锁工具使打开可锁定的链条锁以清洁或更换链节变得更加容易。

9540 Kraftform XL 饮水瓶组套



17 件螺丝刀组套；包括可再装的 Elite Fly 饮水瓶。

2 把用于旋拧、凿切和榫接的凿子，2 个用于十字螺丝的带 Lasertip 的 Kraftform 螺丝刀，2 个用于 TORX® 螺丝的 Kraftform 螺丝刀，2 个 Kraftform VDE 螺丝刀，160 iS 具有缩小刀杆直径和用于一字螺丝的集成保护绝缘，162 i 带 Lasertip，6 个 BitTorsion 批头，一个批头夹持螺丝刀，一个 Bit-Check，空袋。

05100028001		
	9541 饮水瓶	1x 550
⊖	932 A	1x 1,0x5,5x100; 1x 1,2x7,0x125
⊕	350	1x PH 1x80; 1x PH 2x100
⊗	367 TORX®	1x TX 20x100; 1x TX 25x100
⊖	160 iS VDE	1x 0,6x3,5x100
⊕	162 i VDE PH	1x PH 2x100
	Bit-Check 7 工具查找装置 1，空	
⊙	893/4/1 K	1x 1/4"x50
⊕	851/1 BTZ	1x PH 2x25
⊕	855/1 BTZ	1x PZ 1x25; 1x PZ 2x25
⊗	867/1 TORX® BTZ	1x TX 15x25; 1x TX 20x25; 1x TX 25x25

户外活动用饮水瓶



采用 Wera 设计的 Elite Fly 饮水瓶，容量为 550 ml。非常适合户外活动。也适用于所有标准自行车水瓶架。

Bit-Check 中的批头和批头夹持螺丝刀

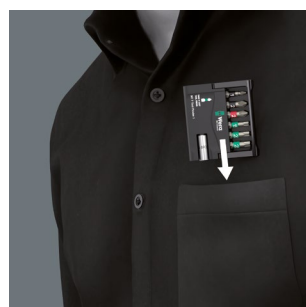

维拉的 Bit-Checks 批头套装极为紧凑，是随身携带的理想伙伴。

Bit-Check 30 TX 通用型 1 SB



零售用包装上架

1个通用批头接杆，带不锈钢护套、卡环和强磁性磁铁。29个批头，耐用，通用型

05057900001	
1x Bit-Check 30 TX 通用型 1	
899/4/1	1x 1/4"x50
867/1 TORX®	3x TX 10x25; 5x TX 15x25; 8x TX 20x25; 7x TX 25x25; 4x TX 30x25; 2x TX 40x25

Bit-Check 30 Wood 2 SB



零售用包装上架

1个通用批头接杆带不锈钢护套、卡环和强磁性磁铁。29个批头，耐用，通用型

05057438001	
1x Bit-Check 30 Wood 2	
899/4/1	1x 1/4"x50
851/1 Z	1x PH 2x25
855/1 Z	2x PZ 1x25; 5x PZ 2x25; 2x PZ 3x25
867/1 TORX®	3x TX 10x25; 4x TX 15x25; 4x TX 20x25; 4x TX 25x25; 3x TX 30x25; 1x TX 40x25

Bit-Check 30 金属型 1 SB



零售用包装上架

1个通用批头接杆带不锈钢护套、卡环和强磁性磁铁。29个批头，耐用，通用型

05057440001	
1x Bit-Check 30 金属型 1	
899/4/1	1x 1/4"x50
851/1 Z	3x PH 1x25; 3x PH 2x25; 2x PH 3x25
855/1 Z	3x PZ 1x25; 3x PZ 2x25; 3x PZ 3x25
867/1 TORX®	1x TX 10x25; 1x TX 15x25; 1x TX 20x25; 1x TX 25x25; 1x TX 30x25; 1x TX 40x25
800/1 Z	1x 0.6x4.5x25; 1x 1.0x5.5x25; 1x 1.2x6.5x25
840/1 Z	1x 4.0x25; 1x 5.0x25; 1x 6.0x25

带卡环的通用夹具



卡环和永久性强磁性确保夹具能安全牢固地夹持批头。

放置于工作场所



Bit-Checks批头套装可以直立放置在工作场所，便于取用。

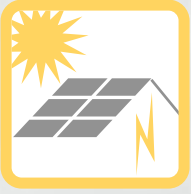

9524 光伏安装工具组套 1



安装光伏系统的 7 件工具组套。一把 7442 扭矩扳手 (枪形手柄), 测量范围为 3.0-6.0 Nm。一把 889/4/1 F Rapidaptor 批头夹持螺丝刀, 具有快速旋转功能, 在顺时针扭矩操作过程中无需取下工具即可快速返回。一把 6003 Joker 环形扳手。用于 MC4 太阳能连接器 (多触点) 的 2 个安装工具。一个用于安装面板连接器的 17 号 1/2" 套筒扳手嵌件 (一字)。一个工具轴 (适配器 1/4" 至 1/2"), 用于手动操作的方头套筒。

05136043001		
●	7400 枪形手柄	1x 7442, 3,0-6,0 Nm
●	8790 HMC Deep, 带切口	1x 17,0x76,0
○ ○	870/4 A	1x 1/4"x1/2"x72
● ○	889/4/1 F	1x 1/4"x64
	6003 Joker	1x 17x190
	9108	2x 115
	魔术贴 120	1x 50,0x120,0

用于 MC4 太阳能连接器的 9108/2 PV 安装工具组套



应用: 用于拧紧和松开电缆连接以及释放插头连接的锁定; MC4 太阳能连接器 (多触点)。

设计: 玻璃纤维增强塑料

05136700001		
	9108	2x 115

用于安装太阳能系统



该组套包括安装太阳能系统所需的螺丝刀工具, 如扭矩扳手、环形扳手和太阳能连接器的安装工具。

设置简单



可以直接手动设定所需的扭矩数值。

用于 MC4 太阳能连接器的安装工具

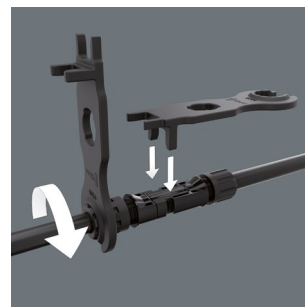

用于拧紧和松开电缆连接以及释放插头连接的锁定。

一字套筒扳手



特别适合安装温度传感器、热开关和其他从顶部和侧面布线的组件。



用于热泵/空调的 9530 扭矩扳手组套



4 件组套；置于表面柔顺、节省空间且坚固耐用的帆布工具袋内。尺寸小，重量轻，便携。

一个 Click-Torque X 7 扭矩扳手，配备用于嵌件工具的 14x18 mm 支座，测量范围 10-100 Nm，准确度为设定值的 $\pm 4\%$ ，依照 DIN EN ISO 6789-1:2017-07，适用于顺时针和逆时针扭矩控制，方便设置和保存所需的扭矩，可在达到标尺值时发出提示音并进行触摸式锁止（精细标尺仅为牛顿米），可在达到设定的扭矩值时发出提示音并启动触摸式释放机构，采用人机工学设计的 2 组件式手柄；3 个带棘轮功能的自定位 Joker 7880 嵌件扳手。

05136076001	Click-Torque X 7	1x 14x18, 10-100 Nm
	7880 Joker XXL	1x 14x18x24-32x ¹⁵ / ₁₆ "-1 1/4"x113,5
	7880 Joker XL	1x 14x18x19-24x ³ / ₄ "- ¹⁵ / ₁₆ "x95,0
	7880 Joker L	1x 14x18x16-19x ⁵ / ₈ "- ³ / ₄ "x85,5

用于空调管路



使用 9530 组套，可以正确拧紧用于制冷和空调系统以及热泵管路的螺纹接头。



自动连续自定位

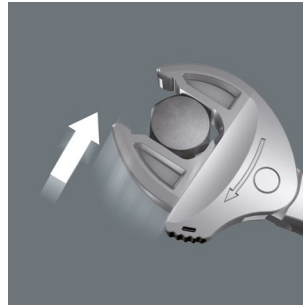

Joker 7880 自动且持续地握住平行卡爪，覆盖了潜在工作范围内的所有尺寸。将工具连接到螺栓或螺丝上时，工具本身即可找到所需尺寸。



Joker 7880: 快速工作的棘轮机构

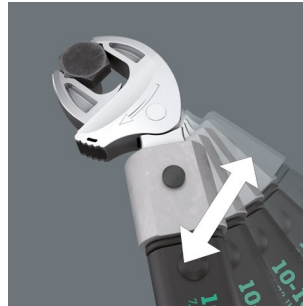

开口的棘轮功能快速拧紧螺丝，无任何滞顿。

用于嵌件工具的 Click-Torque X 7 扭矩扳手，10-100 Nm



应用： 用于顺时针和逆时针扭矩控制

精度： 根据 DIN EN ISO 6789-1:2017-07，精度为设定值的 $\pm 4\%$

设计： 带有可更换嵌件工具 14x18 mm 的支座；方便设置和保存所需的扭矩，可在达到标尺值时发出提示音并进行触摸式锁止（精细标尺仅为牛顿米），可在达到设定的扭矩值时发出提示音并启动触摸式释放机构

手柄： 人体工程学双重材料手柄

05075657001	14x18	10-100	0.5	7-73	372	25.5	329.0	140	47	29	20	14 41/64"	5 33/64"	1 27/32"	1 9/64"	25/32"
-------------	-------	--------	-----	------	-----	------	-------	-----	----	----	----	-----------	----------	----------	---------	--------

S_k = 试验配件到支点的深度； l_k = 抓取位置到扭力测量点的范围

7880 Joker XXL 自定位插入式扳手，适用于尺寸为 24-32 mm、14x18 mm 的扳手



应用： 六角螺丝和螺栓

驱动： 14x18 mm；适用于带有 14x18 mm 支座的 Click-Torque X 和 XP 系列扭矩扳手

设计： 带棘轮功能的自定位扳手；开口侧的尺寸可调，钳口平行光滑；钳口中有角宽棱形体，因此带 30° 反向旋转角度

	mm	mm	mm	mm
05020173001	14x18	24-32	15/16"-1 1/4"	113.5

7880 Joker XL 自定位插入式扳手，适用于尺寸为 19-24 mm、14x18 mm 的扳手



应用： 六角螺丝和螺栓

驱动： 14x18 mm；适用于带有 14x18 mm 支座的 Click-Torque X 和 XP 系列扭矩扳手

设计： 带棘轮功能的自定位扳手；开口侧的尺寸可调，钳口平行光滑；钳口中有角宽棱形体，因此带 30° 反向旋转角度

	mm	mm	mm	mm
05020172001	14x18	19-24	3/4"-15/16"	95.0

7880 Joker L 自定位插入式扳手，适用于尺寸为 16-19 mm、14x18 mm 的扳手



应用： 六角螺丝和螺栓

驱动： 14x18 mm；适用于带有 14x18 mm 支座的 Click-Torque X 和 XP 系列扭矩扳手

设计： 带棘轮功能的自定位扳手；开口侧的尺寸可调，钳口平行光滑；钳口中有角宽棱形体，因此带 30° 反向旋转角度

	mm	mm	mm	mm
05020171001	14x18	16-19	5/8"-3/4"	85.5

为正确设置扭矩, 针对问题的新解决方案

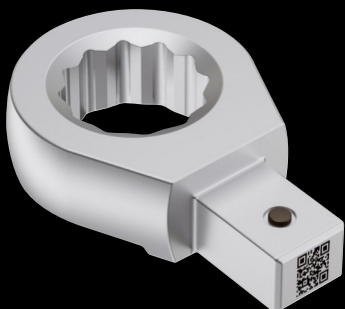

问题是：

扭矩工具的插入工具的几何形状不同，这会改变需要设置的扭矩值。要达到正确的设置值，必须将各种几何形状输入公式：在工作场所要做到这点比较麻烦，而且通常不可行。

解决方案是：

扭矩工具和插入工具上印上二维码（包含所需值）。扫描二维码 → 输入以Nm为单位的所需扭矩值 → 读取要设置的实际Nm值：完成。不需要应用程序即可完成。

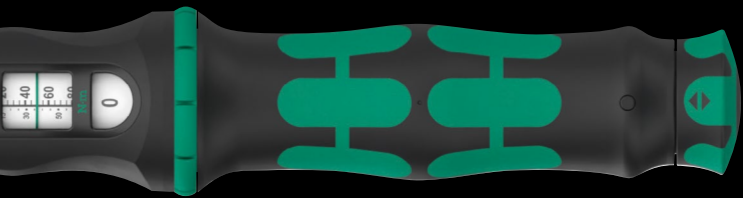

咋哒扭矩 X 扳手的校准

该工具通过扭力测试器进行校准,其间距指定为“ S_k ”。如果您使用的工具的轨距长度“ S_k ”,则实际释放扭矩将根据下表公式变化。

$$M_s = \frac{M_A \times l_k}{l_k + (S - S_k)}$$

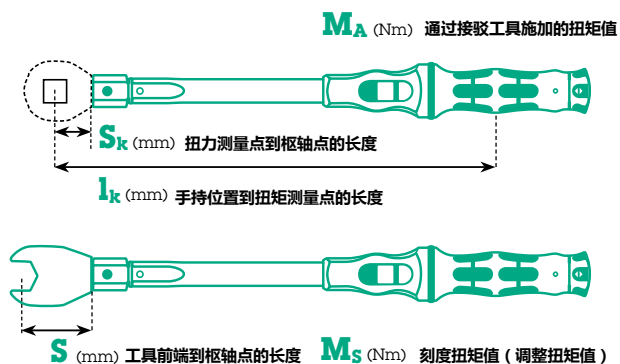

新

简单无误地确定扭矩值



激光雕刻的耐磨二维码使得根据使用的扭矩扳手和嵌件工具确定正确的扭矩值变得更加容易。只需用智能手机和平板电脑扫描(如果有,两个二维码:扭矩扳手和嵌件工具)。网站会自动打开,识别扫描的工具(无需应用程序!)。然后输入所需的扭矩值;校正值是自动确定的。不需要使用公式/计算。



Safe-Torque A 1 SHK 组套 1, 1/4"方头, 2-12 Nm



20 件组套；置于表面柔顺、节省空间且坚固耐用的帆布工具袋内。尺寸小，重量轻，便携。

1 个 Safe-Torque A 1 扭矩扳手，1/4" 方头驱动，测量范围 2-12 Nm；用于顺时针和逆时针控制的扭矩操作；拧紧松动，带或不带扭矩，可分离的扭矩功能（扭矩锁功能）；72 齿；5° 回转角低；设定和保存所需扭矩值容易，达到刻度值时有声音和触觉锁定，达到设定扭矩时有滑脱释放机构；人体工程学 2 部件手柄；8 个 Zyklop 套筒，9 个 Zyklop 批头套筒（六角套筒，TORX®），一个带快速旋转套筒的 Zyklop 加长件，短



滑动机构防止打过扭矩



Safe-Torque A 1 扭矩扳手配有防超扭滑动机构。达到设定扭矩后，不能对工具进行过度拧紧，以免施加过度扭矩。



扭矩锁定功能



扭矩功能可以停用。然后，Safe-Torque 扳手也可用作具有高松动扭矩的标准棘轮，并可用于具有规定旋转角度的应用。



针对顺时针和逆时针运行



Safe-Torque 扳手适用于设定扭矩的顺时针和逆时针操作。扭矩锁功能停用时，无需扭矩即可进行紧固松动。

05136073001		
⊖	Safe-Torque A 1	1x 1/4", 2-12 Nm
⊙	8790 HMA	1x 5,5x23,0; 1x 6,0x23,0; 1x 7,0x23,0; 1x 8,0x23,0; 1x 10,0x23,0; 1x 11,0x23,0; 1x 12,0x23,0; 1x 13,0x23,0
⊗	8767 A HF	1x TX 15x28,0; 1x TX 20x28,0; 1x TX 25x28,0; 1x TX 30x28,0
⊖	8740 A HF	1x 3,0x28,0; 1x 4,0x28,0; 1x 5,0x28,0; 1x 6,0x28,0; 1x 8,0x28,0
	Belt A 0/9	1x 39,0x238,0
⊖	8794 SA	1x 1/4"x75,0
	魔术贴 240	1x 50,0x240,0

9529 C SB 散热器用5阶扳手 1/2"



驱动: 1/2"

应用: 散热器, 温度调节及排水配件等紧固作业

版本: 5阶: 3/8", 7/16", 1/2", 16 和 21 mm; 特殊合金钢, 亚光镀

05136074001	mm	88,0
-------------	----	------

Wera 2go SHK 1 工具组套，用于管道、供暖和空调操作



30 件组套，用于 HVAC 服务的工具组套；一个坚固耐用的 Wera 2go 2 工具容器，带有钩环扣件系统，可连接其他 Wera 2go 组件和带有钩环扣件的 Wera 织物盒和织物袋，包括一个可拆卸的带手柄的箭筒和可调节的钩环分隔器，最多可用于 5 个内部隔间，一把用于旋拧、凿切和榫接的凿子，4 个 VDE 螺丝刀，2 个带空心轴的套筒螺丝刀，一个 Wera Zyklop 金属开关棘轮 ($1/2"$)，4 个 Zyklop 套筒 ($1/2"$)，一根皮带 C (织物皮带)，用于最多 6 个空套筒扳手嵌件、4 个 Joker 双扳手、一个用于内六角螺丝的 950/9 Hex-Plus L 型扳手机组套、一个 Wera Radiator 台阶型扳手、1 个 KNIPEX® 组合钳 (160 mm, 货号 03 01 160)、1 个 KNIPEX® COBRA® 水泵钳 250 mm (货号 87 11 250)、1 个 KNIPEX® 对角绝缘剥离器 (货号 14 26 160)、一把适用于所有标准关闭系统的 KNIPEX® pro 扳手 (货号 00 11 04)、一把 PUK® 手锯 (货号 2200)、一把 Lyra® 建筑记号笔 (货号 4494202)、一把 STABILA® 水平尺 (型号 70, 30 cm, 货号 02281)、一把 STABILA® 木制折叠尺 (型号 607, 2 m, 浅黄色, 货号 01104)、一把 400g PICARD® 铆钉锤，德国形状 (货号 000101-0400)，一把 BESSEY® 折叠刀 DBKPH-EU。

Wera 2go SHK 1: 用于暖通空调服务 (管道、供暖和空调)



丰富的 30 件工具组套置于紧凑型 Wera 2go 2 便携组合内，用于暖通空调应用。

散热器用 5 阶扳手

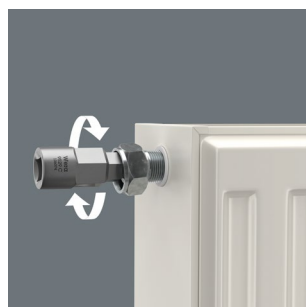

5 阶扳手可用于散热器，温度调节及排水配件等紧固作业。5 阶 ($3/8"$, $7/16"$, $1/2"$, 16 和 21 mm)。

05136071001	1x	Wera 2go 2
	1x	932 A 一字螺丝刀, 1.2 x 7.0 x 125 mm
	1x	395 H0 螺母螺丝刀, 10.0 mm x 90 mm
	1x	395 H0 螺母螺丝刀, 13.0 x 90 mm
	1x	1060 i 电设用 绝缘 Kraftform 一字螺丝刀, 0.6 x 3.5 x 100 mm
	1x	1060 i 电设用 绝缘 Kraftform 一字螺丝刀, 1.0 x 5.5 x 125 mm
	1x	1062 i 十字电设用 绝缘 Kraftform 十字螺丝刀, PH 1 x 80 mm
	1x	1062 i 十字电设用 绝缘 Kraftform 十字螺丝刀, PH 2 x 100 mm
	1x	8004 C Zyklop Metal 拨杆式换向棘轮扳手, $1/2"$ 驱动, $1/2$ 英寸 x 281 mm
	1x	8790 HMC Zyklop 套筒, $1/2"$ 驱动, 10.0 mm
	1x	8790 HMC Zyklop 套筒, $1/2"$ 驱动, 13.0 mm
	1x	8790 HMC Zyklop 套筒, $1/2"$ 驱动, 17.0 mm
	1x	8790 HMC Zyklop 套筒, $1/2"$ 驱动, 19.0 mm
	1x	套筒条带 (织物带) C, 6 个位置
	1x	6002 Joker 双开口扳手, 10 + 13 x 167 mm
	1x	6002 Joker 双开口扳手, 17 + 19 x 235 mm
	1x	6002 Joker 双开口扳手, 24 + 27 x 280 mm
	1x	6002 Joker 双开口扳手, 30 + 32 x 305 mm
	1x	950/9 Hex-Plus 2
	1x	9529 C SB 散热器用 5 阶扳手 $1/2"$
	1x	KNIPEX® 水泵钳 COBRA® 250mm 87 11 250
	1x	KNIPEX® 万能钳 160mm 03 01 160
	1x	KNIPEX® 斜口绝缘剥离器 14 26 160
	1x	用于标准关闭系统的 KNIPEX 001104 Pro 扳手
	1x	STABILA® 水平仪 70 式, 30 cm, 02281
	1x	STABILA® 木质折叠尺 607 式, 2 m, 淡黄色, 01104
	1x	PICARD® 钳工锤 400 g, 德式, 000101-0400
	1x	PUK® 2200 手锯
	1x	BESSEY® 刀片 DBKPH-EU 弹簧刀
	1x	Lyra® 施工标记用笔 4494202

Kraftform Kompakt 400 RA SHK 组套 1



19 件组套

带有一个 416 RA T 型柄带棘轮功能的批头夹持螺丝刀和快速脱落卡盘的帆布工具袋, 1个Kraftform 816 R可装卸式伸缩刀杆, 带 Rapidaptor快速接头, 15个硬批头,

05136072001		
●	416 RA	1x 1/4"x45
●	816 R	1x 1/4"x119
+	851/4 Z	1x PH 2x89
+	855/4 Z	1x PZ 2x89
+	855/4 PZ/S	1x # 1x70; 1x # 2x70
+	867/4 Z TORX®	1x TX 15x89; 1x TX 20x89; 1x TX 25x89; 1x TX 30x89
○	840/4 Z	1x 2,0x89; 1x 2,5x89; 1x 3,0x89; 1x 4,0x89; 1x 5,0x89; 1x 6,0x89 ¹⁾ ; 1x 8,0x89 ¹⁾
●	869/4 M	1x 8,0x50,0; 1x 10,0x50,0
	魔术贴 120	1x 50,0x120,0

¹⁾ 六角形刀片

手柄棘轮机构

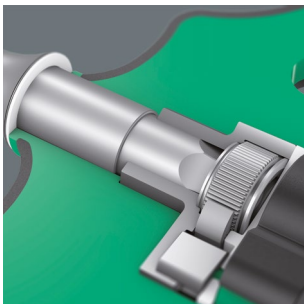

416 RAT 型柄插换式螺丝刀的棘轮机构完全嵌入在手柄中。工具形状紧凑, 工作方便。

454/5 HF SHK 组套 1 T 型柄螺丝刀组套, Hex-Plus 带固持功能

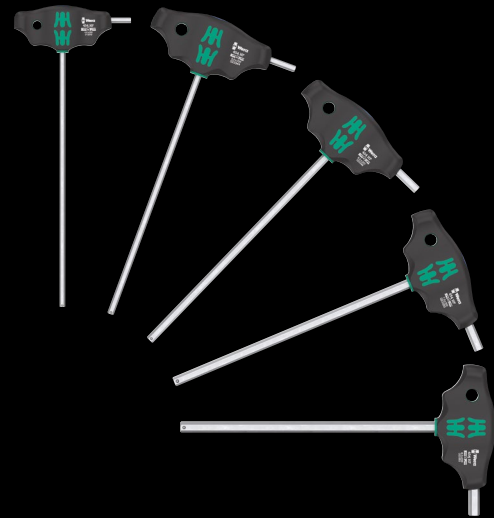

应用: 内六角螺丝, 长臂处具有带固持功能的 T 型柄螺丝刀

设计: 5个带 "Take it easy" 工具查找装置的 Hex-Plus T 型柄螺丝刀: 用特定颜色代表不同端头种类 (蓝色 = 内六角螺丝) 和尺寸

05136070001		
○	454 HF	1x 4x200; 1x 5x200; 1x 6x200; 1x 7x200; 1x 8x200

Bit-Check 6 SHK 1 SB



6个批头, 扭转形状 (T) 防止过早磨损, 韧性 (Z), 通用。分类特别适合于管道、供暖和空调操作。

05073631001		
	1x Bit-Check 6 SHK 1	
+	851/4 TZ	1x PH 1x50
+	867/4 Z TORX®	1x TX 15x50; 1x TX 20x50; 1x TX 25x50
○	840/4 Z	1x 5.0x50; 1x 6.0x50 ¹⁾

¹⁾ 六角形刀片

Kraftform Kompakt 27 XL SHK 1



应用： 适用于符合 DIN ISO 1173-C 6.3 和 E 6.3 要求的带 1/4" 外六角驱动头的批头，以及 Wera 连接系列 1、4

设计： 300 mm 长的刚性刀杆；紧凑的不锈钢支架和强大的永磁铁。安全的批头夹持功能得益于锁定机制。

手柄： Kraftform，带防倾保护，多重材料，集成式批头库

05136075001		
+	851/1 Z	1x PH 2x25
⊕	867/1 TORX®	1x TX 15x25; 1x TX 20x25; 1x TX 25x25
○	840/1 Z	1x 5,0x25; 1x 6,0x25
●	394 S	1x 1/4"x300

Kraftform Kompakt 27 XL 通用型 1



应用： 适用于符合 DIN ISO 1173-C 6.3 和 E 6.3 要求的带 1/4" 外六角驱动头的批头，以及 Wera 连接系列 1、4

设计： 300 mm 长的刚性刀杆；紧凑的不锈钢支架和强大的永久磁铁。安全的批头夹持功能得益于锁定机制。

手柄： Kraftform，带防倾保护，多重材料，集成式批头库

05051028001		
+	851/1 BTZ	1x PH 1x25; 1x PH 2x25
+	855/1 BTZ	1x PZ 2x25
⊕	867/1 TORX®	1x TX 15x25; 1x TX 20x25; 1x TX 25x25
○	394 S	1x 1/4"x300

300 mm 长的刀杆



300 mm 长的刀杆使其能够触及难以触及的联轴器。

牢牢固定而且容易取用



采用锁止机构，具有安全的批头固定功能。带强磁性磁铁。

Kraftform Kompakt 27 XL 通用型 Imperial 组套 1

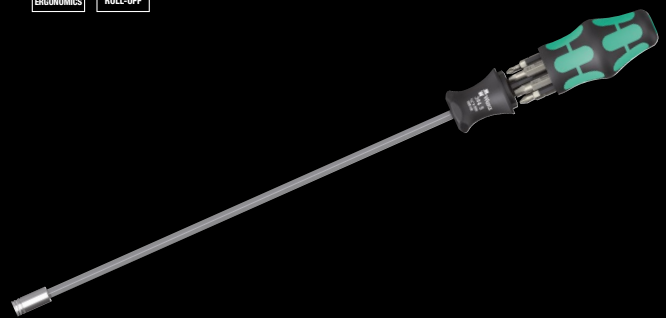

应用： 适用于符合 DIN ISO 1173-C 6.3 和 E 6.3 要求的带 1/4" 外六角驱动头的批头，以及 Wera 连接系列 1、4

设计： 300 mm 长的刚性刀杆；紧凑的不锈钢支架和强大的永久磁铁。安全的批头夹持功能得益于锁定机制。

手柄： Kraftform，带防倾保护，多重材料，集成式批头库

05051032001		
+	851/1 Z	1x PH 1x25; 1x PH 2x25
+	800/1 Z	1x 1,0x5,5x25; 1x 1,2x6,5x25
○	868/1 Z	1x # 1x25; 1x # 2x25
●	394 S	1x 1/4"x300

促销期间：01.03.2024–28.02.2025

敝司将保留可对本目录中所记载和产品特点，种类和执行相关的内容进行更新或修改的权利，事前无需预告。敝司无需对任何因为印刷造成的错误和误导负责。

欢迎联络我们

中国经销代理

凯尼派克工具（上海）有限公司

Phone: +86 (0) 21-58998010
Fax: +86 (0) 21-58998050

E-Mail: info@knipex.com.cn
Internet: www.knipex.com.cn

铭洋工业自动化（上海）有限公司

Phone: +86 (0)21 - 66 24 91 22

E-Mail: service@matfron.com

亚洲总部

Wera Tools Japan G.K.

Phone: +81 70 4813 1142

E-Mail: frank.yang@wera.de

